

LIGHTYEARS®
REPUBLIC OF **Fritz Hansen**®

WELCOME

Welcome to the illuminating universe of Lightyears® – Republic of Fritz Hansen™. Working closely with internationally recognized designers and architects, Lightyears develops and manufactures high-quality, modern lighting that unites tradition and innovation, continuing Fritz Hansen's proud traditions of exquisite craftsmanship, quality, and timeless design.



AEON ROCKET™

DESIGNED BY MORTEN VOSS

Aeon Rocket™ is the first pendant in history to take full advantage of the luminous qualities of metal and polypropylene simultaneously in a single pendant design. The lamp strikes a fine balance between a simple metal upper shade and a gauzy lower shade. However, the impression of lightness is created by hours and hours of meticulous manual work. 8 light bands made of recyclable polypropylene are carefully woven together into 100 and 98 round wopenings respectively, allowing the light to stream through unhindered.

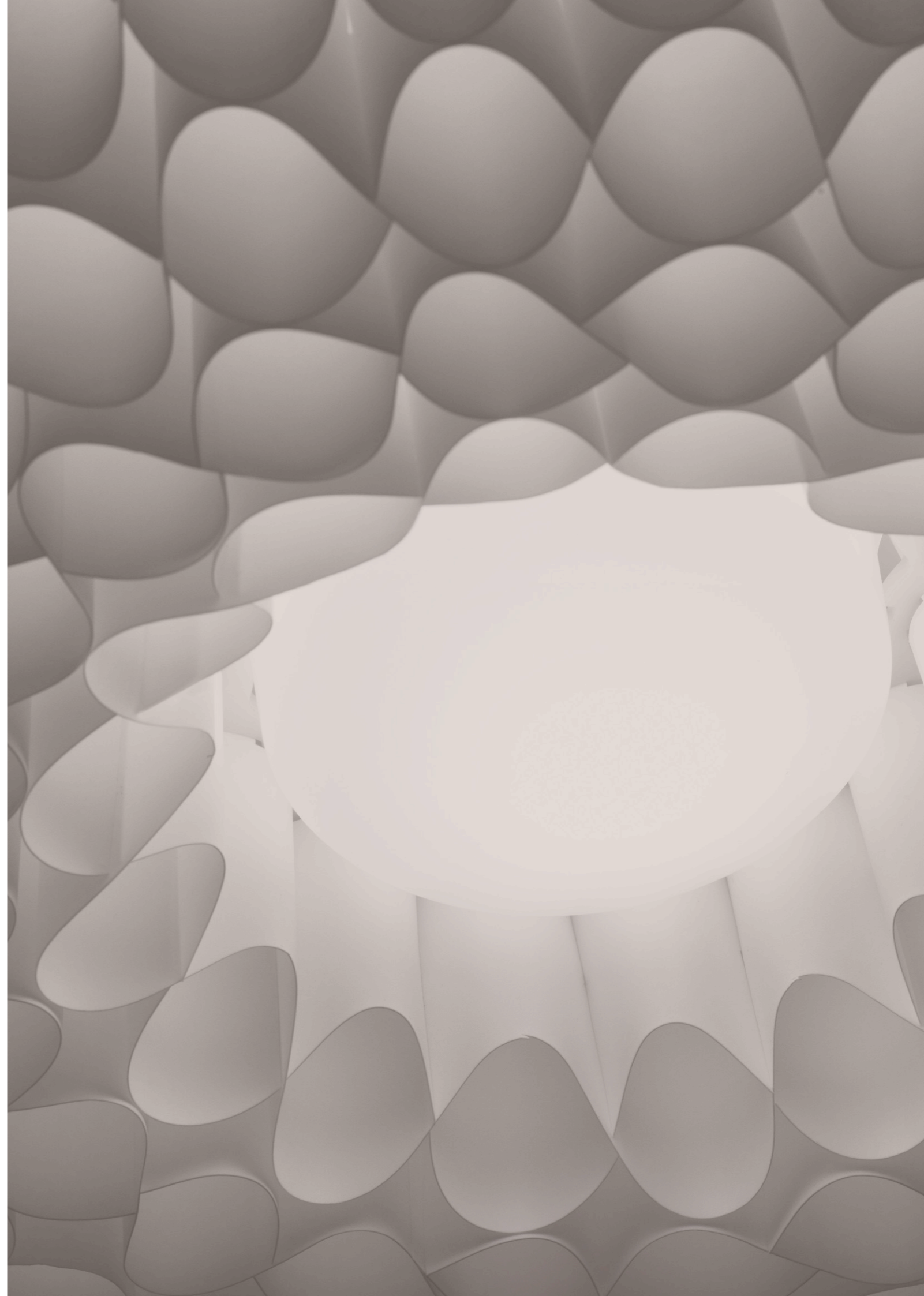



AQ01™

DESIGNED BY ANNE QVIST

The AQ01™ desk light reveals a recognisable design expression while offering an innovative take on refined details and curved lines. With its curvy edges and matte finish, the AQ01™ shade is designed to attract the human hand and can be switched on and off or dimmed directly on its head. The diffuser is made using a thicker material to prevent glare and to give off 100 percent direct downward illumination in a symmetric rotational pattern. The delicate arms connecting the two joints hide the wire within and keep it in place with an internal spring, keeping the lamp's elegant exterior clear of excess visual elements. As a desk light, the AQ01™ can be installed as a plug-in or placed in a table base, and looks equally alluring with the wall bracket as a reading light or as a bedside light.



AVION™

DESIGNED BY ISKOS-BERLIN

A childhood fascination with Zeppelin airships gliding with steady grace across the sky, inspired Iskos-Berlin to create Avion™. Despite its substantial size, the large, oval pendant hovers playfully in the air, ready to change its direction to suit your desire. The pendant light is made of polyethylene and emits a soft, diffuse light that creates a cosy, natural atmosphere in the room. Avion™ can be arranged in a regular formation or as a dynamic pack. Similarly it can be suspended in a line to mark a passage through a building.



BULB FICTION™

DESIGNED BY KIBISI

Bulb Fiction™ is close to the classic incandescent bulb, but the shape has been upscaled and designed as a whole unit, uniting socket and bulb into one iconic shape. The same applies to the cord, which has been given extra volume using a thick, white silicone cover. Bulb Fiction™ consists of a hand-blown acid-treated opal glass shade and an aluminium suspension with a soft, organic shape.



CALABASH™

DESIGNED BY KOMPLOT DESIGN

Calabash™ is authentic craftsmanship from the core to the surface. The organic design idiom and the specially chromed and slightly changeable surface provide Calabash™ with a unique expression. Every pendant goes through a comprehensive 4-step lacquering process, which is exclusively carried out by hand. The three pendant sizes present the same easily recognisable shape, although without being identical.





CARAVAGGIO™

DESIGNED BY CECILIE MANZ

The Caravaggio™ range of high-gloss pendants was launched in 2005 and instantly singled out as a design icon. The distinctive red cord and the polished surface, clearly highlight one of the most striking pendant designs of the 2000s. The praised Cecilie Manz design elegantly combines a recognisable shape with a modern expression.



CARAVAGGIO™ MATT

DESIGNED BY CECILIE MANZ

The completely matt finish adds a rare depth and tangibility to the well-known and elegant Caravaggio™ design, imbuing it with a warm, cosy feel. The delicate black, white and two grey tones are carefully balanced and interact elegantly with each other, if you choose to mix the pendants in your interior design solution. The discreet tones are timeless and suit more-or-less all settings.

NEW TONES 2018 - With this line extension the new tones chosen for the Caravaggio™ Matt pendant have their roots in nature's earthy hues: warm silk, archipelago stone, dark sienna and dark ultramarine. They have depth and they add detail whilst staying true to the classic shape of the renowned design.





CARAVAGGIO™ OPAL

DESIGNED BY CECILIE MANZ

With Caravaggio™ Opal, Cecilie Manz has combined the characteristic design with a completely different lighting effect. The opal glass shade emits a soft, dimmed light, which is particularly suitable for rooms where a more evocative lighting is required. The lamp is suspended by the three well-known shackles, which here form a raw and masculine contrast to the feminine opal hand-blown glass.





CARAVAGGIO™ TABLE – FLOOR

DESIGNED BY CECILIE MANZ

The Caravaggio™ Table and Floor lamp impresses with its minimalistic design yet substantial and sculptural appearance. The table lamp possesses the iconic minimalistic design expression, similar to the floor lamp, but in a smaller and more versatile size. A hidden flexible tube allows the shade to be tilted, adjusting the light cone up to 40°. This function makes the lamp more flexible and functional as a light source. The charming little string close to the light functions as a switch. The Caravaggio™ Table lamp is also available as a plug-in version.





CARAVAGGIO™ READ

DESIGNED BY CECILIE MANZ

Based on the well-known Caravaggio™ shape, Cecilie Manz has created a reading lamp series that is precise, refined and, above all, functional. The iconic shade is installed on a flexible tube, allowing you to tilt the shade and direct the light. The floor, table and wall lamps can be rotated for different needs, which – together with the flextube – makes the lamp very functional. The floor and table lamps are fitted with a 3-step touch-control dimmer for adjustment of light intensity. On the wall lamp, the switch is positioned discreetly at the bottom of the wall bracket to ensure easy access.



CONCERT™

DESIGNED BY JØRN UTZON

Concert™ gives a pleasant, non-glaring light without compromising the strength of illumination. The chosen shade configuration is visually characteristic of Jørn Utzon and reminds us of his greatest work — the Sydney Opera House. Concert™ is designed with four shades and a parabola of drawn steel, resting on a glass cone suspension. The suspension unit sends out a pleasant, even light between the shades. The bottom shade casts light downward to the parabola, which then diffuses it.





CROSS-PLEX™

DESIGNED BY BODIL KJAER

Cross-Plex™ is a pure reflection of the architect and designer Bodil Kjaer's characteristic clean-cut and straight lines – something she uses in everything she has designed. With its clean and straight lines, the Cross-Plex™ lamp is a great example of her functionalistic expression. The lamp is centred on a cross-base of clear acrylic that creates an elegant play of surfaces and incorporates the cord as a central part of the design. The light from the cubic lampshade, shaped in opal acrylic, is designed to create a cosy atmosphere.



DOGU™

DESIGNED BY MICHAEL GEERTSEN

The name Dogu™ is Japanese and refers to old traditional figurines portraying animals and humanoids – much like Michael Geertsen's own art does. The shade is made of bone china – an exclusive material created from actual bone powder and white clay. The translucent material, with suspension in either gold or silver, ensures that the light projects through the shade and renders the lamp light, warm and extremely cosy at the same time. The charming irregularities found in bone china have a lot in common with the beauty marks we experience on natural leather hides. They underline the personality of the material and ensures that no lamps are the same.





HL™

DESIGNED BY HENNING LARSEN

HL™ provides a diffuse light. The HL™ lamp is constructed from warm-galvanized steel, untreated copper and clear/opal acrylic. In time, the untreated copper shade takes on a characteristic dark look and eventually it becomes the classic verdigris colour. Thus the outdoor lamp grows more beautiful year after year.

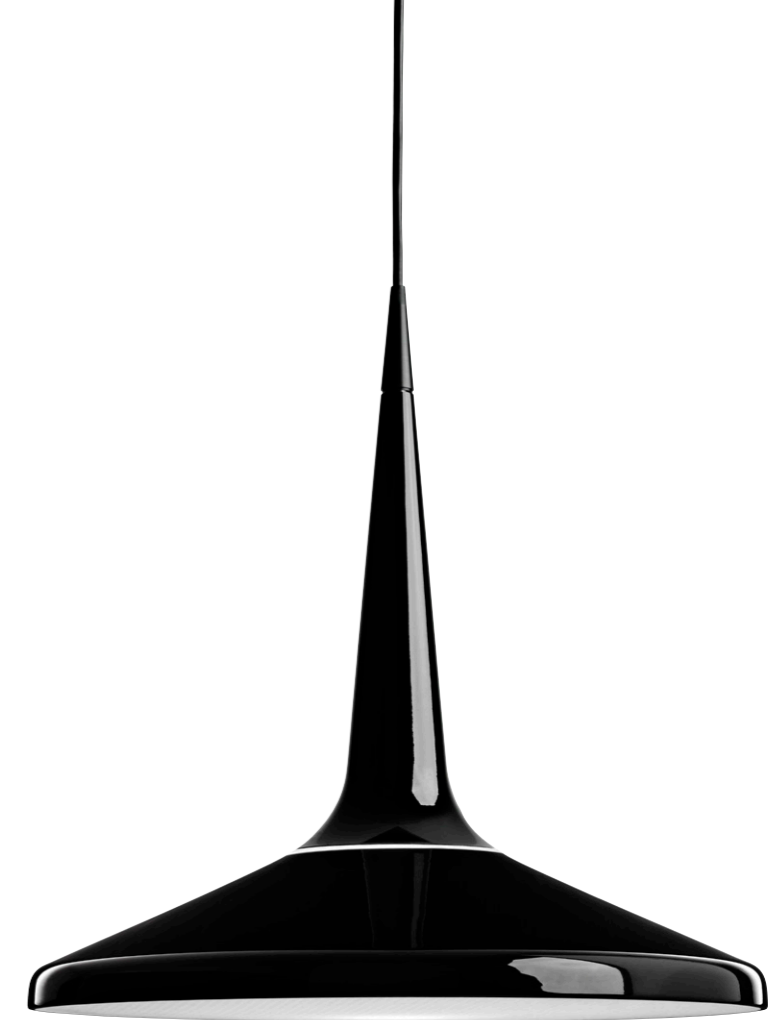

JUICY™

DESIGNED BY SALTO & SIGSGAARD

The Juicy™ pendant is logical, simple and functional. The various parts of the lamps: the wire, cone and shade come together seamlessly, which makes the pendant seem like an organic whole. Towards the bottom, Juicy™ is finished off with a honeycomb-filter, which effectively concentrates the light while preventing dazzle at the same time. The glossy surface is visually broken by a shiny ring, which marks where the lamp can be separated for change of light source.

KAISER idell™ 6631-T

DESIGNED BY CHRISTIAN DELL

The table lamp model 6631 "Luxus" appeared for the first time in 1936, when Gebr. Kaiser & Co. introduced it. This specific lamp soon became the undisputed top model of the KAISER idell™ series and - then, as well as today - the symbol of noble Germanic design, exquisite choice of materials and precise engineering. The KAISER idell™ 6631-T lamp can be adjusted by loosening the clamp at the base or turning the shade.





KAISER idell™ 6580-F

DESIGNED BY CHRISTIAN DELL

The exclusive 6580-F is considered the "Luxus" version of the KAISER idell™ floor lamps with its curvy Bauhaus references to the original 6631-T table lamp launched in 1936. The KAISER idell™ 6580-F floor lamp embodies pure luxury with its stunning chrome details and high quality. A chrome plated clamp allows you to adjust the height, making it both sculptural and functional.





KAISER idell™ 6556-T

DESIGNED BY CHRISTIAN DELL

6556-T is a slim, elegant and functional table lamp, a classic in the KAISER idell™ collection. The world-patented swivel joint and the characteristic dome embossed with "ORIGINAL KAISER-idell" is fitted with a small shade suitable for a window frame, shelf or coffee table. The KAISER idell™ 6556-T lamp can easily be tilted from a 15° to 18° angle - functional and beautiful at the same time.



KAISER idell™ 6556-F

DESIGNED BY CHRISTIAN DELL

The KAISER idell™ 6556-F floor lamp is the result of a long-standing tradition for creating original and timeless design. Its minimalistic design appears both timeless and relevant in time. Suitable for cosy corners, bedrooms, sofas or lounge chairs the lamp will enrich any home. KAISER idell™ 6556-F can easily be tilted from a 15° to 18° - functional and beautiful at the same time.





KAISER idell™ 6631-P

DESIGNED BY CHRISTIAN DELL

The KAISER idell™ 6631-P pendant simply combines two fundamental parts of the world patented design: the iconic swivel joint and the classic shade as seen on the original 6631-T table lamp. The minimalistic and compact design of the KAISER idell™ 6631-P allows you to use the lamp in several settings, be it above your kitchen or dining table, coffee table, in a meeting room or in any open space in need of light and bright design made to last for generations.



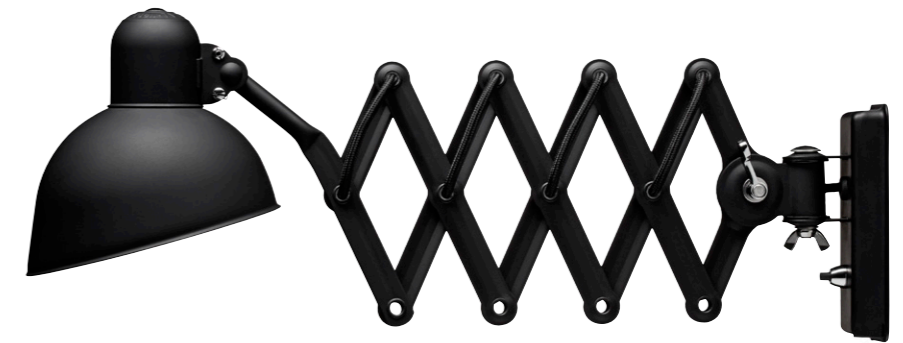

KAISER idell™ 6718-W

DESIGNED BY CHRISTIAN DELL

The KAISER idell™ 6718-W, also known as the "scissor lamp", is a true example of dedicated craftsmanship that looks amazing at the same time. The unique construction of the wall lamp is made from the highest quality materials to ensure that your KAISER idell™ will remain beautiful and durable. The wall mounted lamp has a swivelling shade and a flexible scissor arm with an adjustable length.



LULLABY™

DESIGNED BY MONICA FÖRSTER

The Lullaby™ is formed into a pentagonal, yet slightly organic-looking shape using five slender ash lamellae. The ash gives the diffuse paper shade stability, shape and character. In addition, the shade has outstanding luminous qualities, which enable the Lullaby™ to emit a soft, muted light.



MINGUS™

DESIGNED BY CECILIE MANZ

Mingus™ is organic even if it originates in four straight facets. The lamp's top is flat and fitted with an acrylic fixture that allows light to seep out. The Mingus™ pendant is available in six matt nuances. In addition to Pure White, there are five other tones carefully selected by Cecilie Manz: Nearly Black, Very Grey, Pale Moss, Light Celadon and Dusty Limestone. The tones change in different lights and take on the colour of their surroundings.



NIGHT OWL™

DESIGNED BY NICHOLAI WIIG HANSEN

Nicolai Wiig Hansen's inspiration for designing the Night Owl™ table lamp was the desire to create a warm Nordic, cosy wash of light. The design is effortless, and conveys that this is an informal table lamp. It consists of a conical base and oval shade, merging together to form a single unit of balanced proportions. Its organic design gives the lamp a friendly and almost human appearance – it's a lamp with a personality! Night Owl™ is suitable for standing on e.g. a sideboard, shelf, bedside table or in a window.





ORIENT™

DESIGN BY JO HAMMERBORG

Orient™ was designed by Jo Hammerborg in 1963 and relaunched by Lightyears in 2013, in one of the original five different surfaces. In close collaboration with the Hammerborg family, the Orient™ pendant is a flawless light design with excellent luminous efficacy and made from the finest quality materials. The organic design expression beautifully connects the deep, vibrant copper glow and the rosewood top. The lamp has 21/24 narrow, vertical slots at the top of the genuine copper shade, allowing light to filter through. The pendant ensures a soft, pleasant light without any glare.



ORIENT™

DESIGNED BY JO HAMMERBORG

The Orient™ Black is inspired by the original black design from 1963. The modern interpretation is made in a matt black laquered aluminium version. The matt surface makes the timeless design appear simpler and purer. The black Orient™ shade appears more discreet, while giving a dark gain of the rosewood more prominent role. The large pendant creates new opportunities for interior decoration.





ORIENT™

DESIGN BY JO HAMMERBORG

The characteristic Orient™ pendant in brushed aluminium is not only a light and elegant addition to the existing series of warm and dark colours. It is also a tribute to the original collection where both a copper, a black and a silver coloured version were presented. Nevertheless, this silver coloured aluminium has a personality of its own and renders the design Nordic and exotic at the same time.

The well-known oriental shape creates a fascinating contrast in combination with the cool brushed aluminium. As the cherry on top, a suspension in Scandinavian oak combines the shade with a grey textile cord and truly underlines the Nordic appearance. Optically, the brushed aluminium makes the entire design appear light and almost levitating.



PALLAS™

DESIGNED BY FORMFJORD

Pallas™ is a contemporary large room pendant with a unique character inspired by historic chandeliers. The vertical laser-cut slits in the shade create openings for the light and create a sophisticated interplay of light and shadow. With its substantial size, Pallas™ is made to illuminate grand architectural projects such as lobbies, airports, theatres or museums.



RADON™

DESIGNED BY HANS SANDGREN JACOBSEN

The fundamental geometric forms – the circle and the triangle – are key elements in the design of the Radon™ series. The light from Radon™ is direct and adjustable. The shade is multi-directional and furnished with an asymmetrical reflector, ensuring that light spreads out precisely to the surface where it is needed. The switch is placed at the top of the lamp, while the cord leads discreetly out of the back leg to help preserve the lamp's clean lines.



SUSPENCE™

DESIGNED BY GAMFRATESI

GamFratesi's inspiration for the Suspence™ lamp series is translating a movement into a physical shape. The shape of the lamp has been created by pulling – an elementary movement involving physical force. This tensile force is visible at the top of the lamp, where you see the little tip. Suspence™ is organic with a natural soft curve. The original Suspence™ is available in three monochrome looks, merging shade and cord to be perceived as an uninterrupted whole. A lens at the bottom of the lamp concentrates the light, prevents glare and creates an elegant optical illusion of infinite depth – which is why we named it the “infinity diffuser”.



SUSPENCE™

DESIGNED BY GAMFRATESI

Suspence™ Copper adds a warm and exclusive expression to the already highly acknowledged line of colours in white, light grey and black. This design is not only meant to light up a dark corner, dining table, or kitchen, but is also designed to enrich your entire room with its elegant presence. Because beauty comes in many colours!



SUSPENGE™ NOMAD

DESIGNED BY GAMFRATESI

Suspence™ Nomad is GamFratesi challenging conventional thinking in the typical use of a lamp. The Nomad is designed to be moved around in the home e.g. on the floor, staircase or terrace. It appeals to be moved from place to place, without a permanent residence, just like a nomad. The lamp is easily carried by the silicone handle at the top. Suspence™ Nomad is made of polyethylene, which is a tough material, that gives off a soft, diffuse light – creating a cosy atmosphere.



REFERENCES





BJÖRN, MOSCOW



MEDIA LIBRARY OF THE CAPUCHINS, FRANCE
CREDIT: THOMAS LANG



TARTINERY NOLITA, NEW YORK
INTERIOR DESIGN: SOMA ARCHITECTS, NY



TAYLOR KNIGHTS
PHOTOGRAPHER: SHARYN CAIRNS



SIGNATURE SUITES - RADISSON COLLECTION
ROYAL HOTEL, COPENHAGEN/DENMARK



SIGNATURE SUITES - RADISSON COLLECTION
ROYAL HOTEL, COPENHAGEN/DENMARK



KVIK KITCHEN



ORGATEC 2016, COLOGNE
PHOTOGRAPHER: MARTIN SØLYST



BIG ARCHITECTS, NEW YORK
PHOTOGRAPHER: TAYLOR CROTHERS



BIG ARCHITECTS, COPENHAGEN
PHOTOGRAPHER: TAYLOR CROTHERS



GURU, COPENHAGEN
INTERIOR DESIGN: HENNING LARSEN ARCHITECTS



SUNJIN INTERIOR DESIGN CO. LTD





ALMANAK, COPENHAGEN
INTERIOR DESIGN: CHRISTINA MEYER BENGTSOON & HOLMBÄCKNORDENTOFT



SOHO LOUNGE & MUSIC BAR, HOLBÆK
INTERIOR DESIGN: VESTERGAARD MØBLER



ORGATEC 2016, COLOGNE
PHOTOGRAPHER: MARTIN SØLYST

FACTS

AEON ROCKET™

COLOUR	Aeon-Grey, Aeon-Black	
SURFACE	Matt lacquer	
CORD LENGTH	3 / 6 m	
CORD	Aeon-Grey	Grey25, textile
	Aeon-Black	Grey85, textile
MATERIAL	Shade:	Steel/Aluminium
	Diffuser:	Polycarbonate (PC)
LIGHT SOURCE	P1	E27 max 77W
	P3	E27 max 150W
ENERGY LABEL	A++, A+, A, B, C, D	
ISOLATION CLASS	CLASS II	
IP RATING	IP20	
CERTIFICATION	CE	

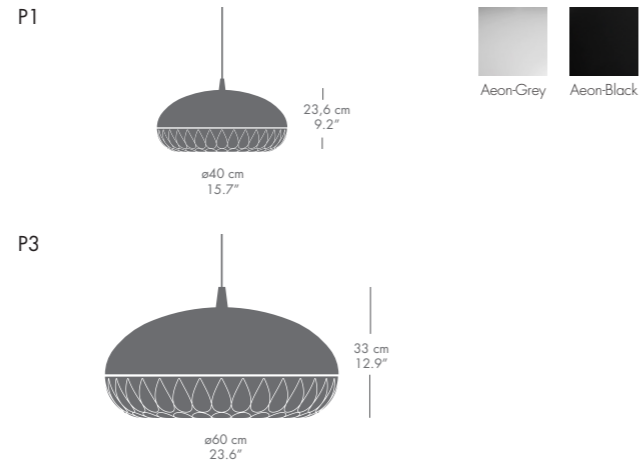

AQ01™

COLOUR/SURFACE	White, Black, Blue	
SURFACE	Matt lacquer	
CORD LENGTH	2 m	
CORD	White	White, PVC
	Black	Black, PVC
	Blue	Black, PVC
MATERIAL	Shade/Base:	Aluminium
	Diffuser:	Polycarbonate (PC)
LIGHT SOURCE	LED (Build in)	
ENERGY LABEL	A+	
ISOLATION CLASS	CLASS II	
IP RATING	IP20	
CERTIFICATION	CE	

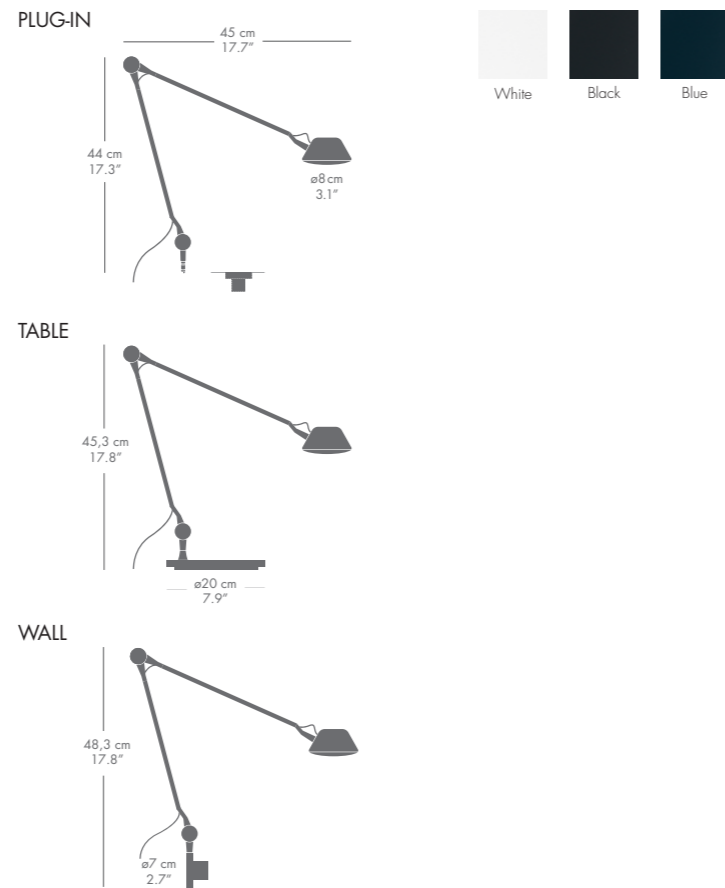

LUMINOUS FLUX	483lm
CONNECTED LOAD	7.7W
LUMINAIRE EFFICACY	62lm/W
COLOUR RENDITION INDEX	>90
LUMEN MAINTENANCE	L70 B50 57.000H
LED FAILURE RATE	10% ≤30.000H
DIMMABLE	YES (STEPLESS)
POTENTIOMETER FOR BRIGHTNESS CONTROL	10 - 100%
ILLUMINANCE	730lx (50cm)
COLOUR TEMPERATURE	3000K

AVION™

COLOUR	Opal	
MATERIAL	Polyethylene (PE)	
CORD LENGTH	6 m	
CORD	White, PVC with wire	
LIGHT SOURCE	E27	E27 max 77W
	DALI/2x42W	GX24Q-4 max 2x42W
ENERGY LABEL	E27	A++, A+, A, B, C, D
	DALI/2x42W	A
ISOLATION CLASS	CLASS II	
IP RATING	IP20	
CERTIFICATION	CE	

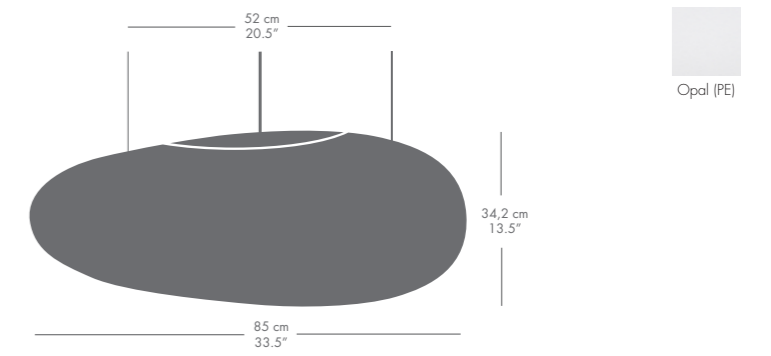

BULB FICTION™

COLOUR	White	
SURFACE	Matt lacquer	
MATERIAL	Shade:	Opal glass
	Suspension:	Aluminium
CORD LENGTH	3 / 6 m	
CORD	White, PVC	
LIGHT SOURCE	E27 max 42W	
ENERGY LABEL	A++, A+, A, B, C, D	
ISOLATION CLASS	CLASS II	
IP RATING	IP20	
CERTIFICATION	CE	

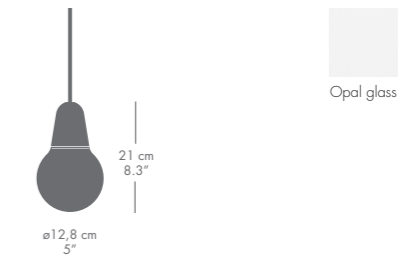

CALABASH™

COLOUR	Silver, Gold	
SURFACE	High-gloss, chrome	
MATERIAL	Shade: Aluminium	
CORD LENGTH	3 / 6 m	
CORD	Black, textile	
LIGHT SOURCE	P1	E27 max 30W
	P2	E27 max 46W
	P3	E27 max 100W
ENERGY LABEL	A++, A+, A, B, C, D	
ISOLATION CLASS	CLASS II	
IP RATING	IP20	
CERTIFICATION	CE	

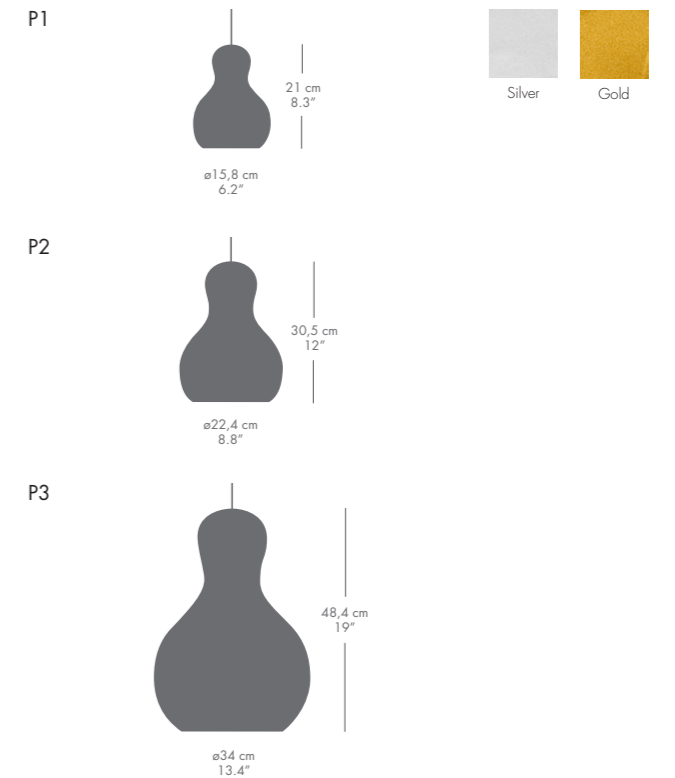

CARAVAGGIO™

SERIES	High gloss, Matt, Opal
COLOUR	HIGH-GLOSS: White, Black, BlackBlack MATT: White, Grey25, Grey45, Black, Warm Silk, Archipelago Stone, Dark Sienna, Dark Ultramarine GLASS: Opal
SURFACE	High-gloss lacquer Matt lacquer
MATERIAL	P0 - P2 Shade: Steel P3 - P4 Shade: Aluminium P0 - P4 Suspension: Steel/Aluminium
ACCESSORIES	P3 - P4 Diffuser: Polycarbonate (PC)
CORD LENGTH	P0 - P2 3 m P2 Opal 3 / 6 m with wire P3 6 m P3 Opal 6 m with wire P4 6 m with wire
CORD	High-gloss White Grey25, textile High-gloss Black Red, textile High-gloss BlackBlack Black, textile Matt White White, textile Matt Grey25 Grey25, textile Matt Grey45 Grey45, textile Matt Black Grey45, textile Warm Silk Grey45, textile Archipelago Stone Grey45, textile Dark Sienna Dark grey, textile Dark Ultramarine Dark grey, textile Opal Silver-grey, textile
LIGHT SOURCE	P0 G9 max 33W P1 E27 max 46W P2 E27 max 100W P3 E27 max 100W P4 E27 max 150W P4 DALI GX24Q-4 max 2x42W P4 2x42 GX24Q-4 max 2x42W
ENERGY LABEL ISOLATION CLASS	A++, A+, A, B, C, D P0 - P3 CLASS II P4 CLASS I
IP RATING CERTIFICATION	IP20 CE

P0



HIGH GLOSS



P1

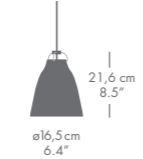

HIGH GLOSS



P2

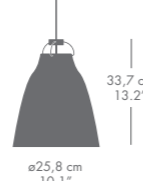

MATT



P3

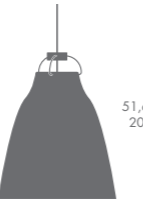

GLASS

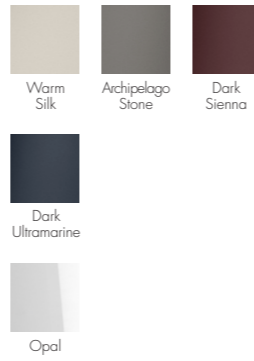

P4



HIGH GLOSS

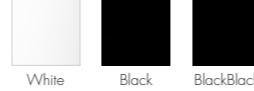

P4 DALI / 2X42W



MATT



P4 DALI / 2X42W



HIGH GLOSS



CARAVAGGIO™ TABLE / FLOOR

SERIES	High gloss, Matt
COLOUR	HIGH-GLOSS: White, Black MATT: Grey25
SURFACE	High-gloss lacquer Matt lacquer
MATERIAL	Shade: Aluminium Base: Steel
CORD LENGTH	Table/Table plug-in 2,50 m Floor 2,50 m
CORD	High-gloss White Grey25, textile High-gloss Black Red, textile Matt Grey25 Grey25, textile
LIGHT SOURCE	Table/Table plug-in E27 max 40W Floor E27 max 150W
ENERGY LABEL ISOLATION CLASS	A++, A+, A, B, C, D CLASS II
IP RATING CERTIFICATION	IP20 CE

CARAVAGGIO™ READ

COLOUR	White, Grey25, Black, Opal
SURFACE	Matt lacquer
MATERIAL	White, Grey25, Black: Shade: Steel Base: Die-cast zink alloy Opal: Shade: Opal glass Base: Die-cast zink alloy
CORD LENGTH	Wall 1,50 m Table/Floor 2,50 m
CORD	White White, PVC Grey25 Grey25, PVC Black Grey45, PVC Opal Grey25, PVC
LIGHT SOURCE*	E27 max 46W *Table/Floor must be dimmable
ENERGY LABEL ISOLATION CLASS	A++, A+, A, B, C, D CLASS II
IP RATING CERTIFICATION	IP20 CE

TABLE

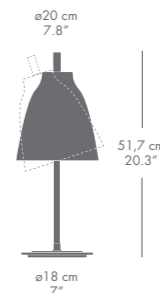

HIGH GLOSS

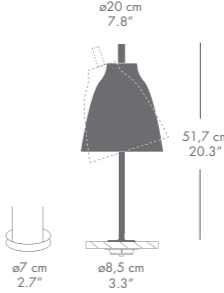



TABLE PLUG-IN



MATT



FLOOR

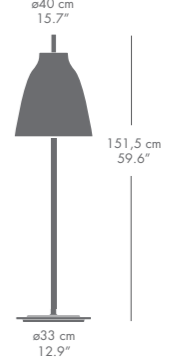

HIGH GLOSS



WALL

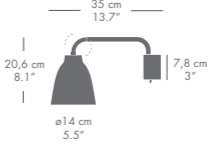

MATT



TABLE

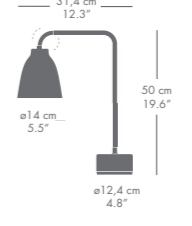

OPAL



FLOOR

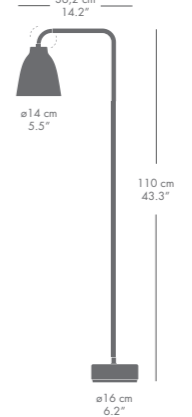

HIGH GLOSS



CONCERT™

COLOUR	White
SURFACE	Matt lacquer
MATERIAL	Shade: Steel Suspension: Acid frosted glass
CORD LENGTH	P1 3 m P3 6 m
CORD	White, textile
LIGHT SOURCE	P1 E27 max 75W P3 E27 max 150W
ENERGY LABEL	A++, A+, A, B, C, D
ISOLATION CLASS	CLASS II
IP RATING	IP20
CERTIFICATION	CE

P1

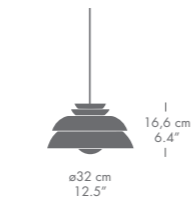

P3

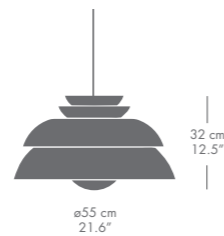

CROSS-PLEX™

COLOUR	Clear/Opal
MATERIAL	Shade: Opal acrylic Base: Clear acrylic
CORD LENGTH	T-300 3 m T-500 3 m
CORD	Black, textile
LIGHT SOURCE	E27 max 70W
ENERGY LABEL	A++, A+, A, B, C, D
ISOLATION CLASS	CLASS II
IP RATING	IP20
CERTIFICATION	CE

T-300

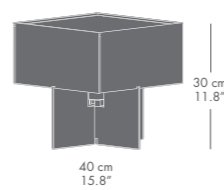

T-500

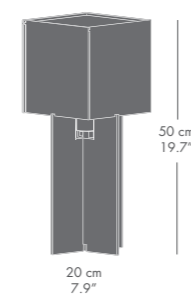

DOGU™

MATERIAL	Shade: Bone china Suspension: Aluminium - gold/silver
CORD LENGTH	3 m
CORD	Gold/silver, textile
LIGHT SOURCE	E27 max 40W
ENERGY LABEL	A++, A+, A, B, C, D
ISOLATION CLASS	CLASS II
IP RATING	IP20
CERTIFICATION	CE

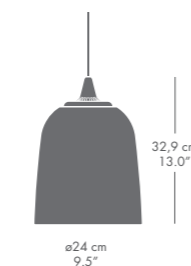

HL™

SERIES	Outdoor
COLOUR	Copper, Acrylic, Galvanized steel
MATERIAL	Upper shade: Untreated copper Lower shade: Clear/Opal acrylic Wall arm: Galvanized steel
LIGHT SOURCE	HL410 E27 max 100W
ENERGY LABEL	A++, A+, A, B, C, D
ISOLATION CLASS	CLASS I, VANDAL CLASS II
IP RATING	IP44
CERTIFICATION	CE

HL410 WALL

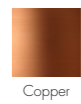
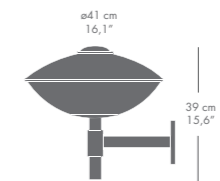

HL410 POST

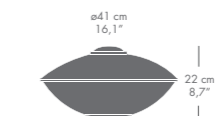

JUICY™

COLOUR	White, Black
SURFACE	High gloss lacquer
MATERIAL	Shade: Die-cast zinc alloy Diffuser: Polycarbonate
CORD LENGTH	6 m
CORD	White White, textile Black Black, textile
LIGHT SOURCE	E27 max 30W
ENERGY LABEL	A++, A+, A, B, C, D
ISOLATION CLASS	CLASS II
IP RATING	IP20
CERTIFICATION	CE

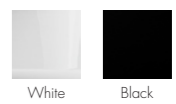
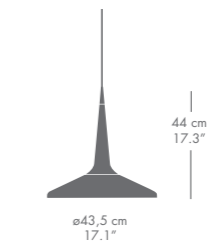

KAISER idell™

COLOUR	White, Black, Dark Green, Ruby Red, Matt Black
SURFACE	High-gloss lacquer Matt lacquer
MATERIAL	Steel/Chrome-plated brass
CORD LENGTH	6631-P 3 m 6631-T 2 m 6556-T 2 m 6556-F 2 m 6580-F 2 m 6718-W 2 m
CORD	Black, textile
LIGHT SOURCE	E27 max 60W
ENERGY LABEL	A++, A+, A, B, C, D
ISOLATION CLASS	CLASS II
IP RATING	IP20
CERTIFICATION	CE

6631-P

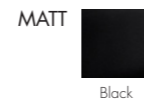
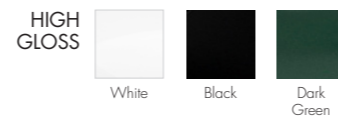
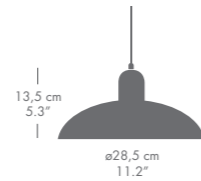

6631-T

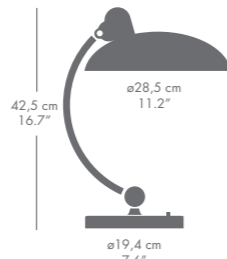

6556-T

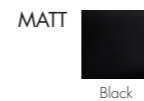

6556-F

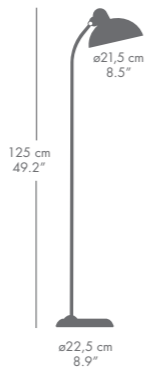

6580-F

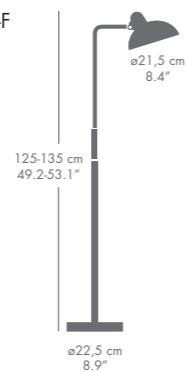

6718-W



LULLABY™

COLOUR	Opal
MATERIAL	Shade: Paper/Ash wood Suspension: Steel
CORD LENGTH	3 / 6 m
CORD	White, textile
LIGHT SOURCE	P1 E27 max 46W P2-P3 E27 max 100W
ENERGY LABEL	A++, A+, A, B, C, D
ISOLATION CLASS	CLASS II
IP RATING	IP20
CERTIFICATION	CE, FSC

P1

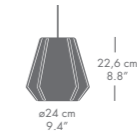

P2

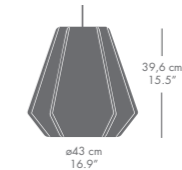

P3

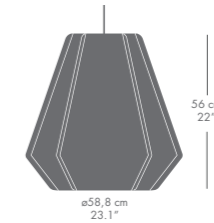

MINGUS™

COLOUR	White, Dusty Limestone, Light Celadon, Pale Moss, Very Grey, Nearly Black, Semi-matt lacquer
SURFACE	
MATERIAL	Aluminium/Acrylic
CORD LENGTH	3 m
CORD	White White, textile All others Grey25, textile
LIGHT SOURCE	P1 E27 max 46W P2 E27 max 70W
ENERGY LABEL	A++, A+, A, B, C, D
ISOLATION CLASS	CLASS II
IP RATING	IP20
CERTIFICATION	CE

P1

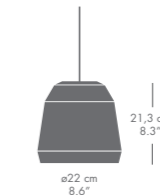

P2

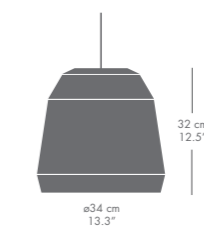

NIGHT OWL™

COLOUR	Midnight Blue (dark blue) Smokey White (off-white)
SURFACE	Matt lacquer
MATERIAL	Shade: Aluminium Base: Aluminium/Ash Diffuser: Polycarbonate (PC)
CORD LENGTH	2 m
CORD	Black, textile
LIGHT SOURCE	E27 max 15W
ENERGY LABEL	A++, A+, A, B, C, D
ISOLATION CLASS	CLASS II
IP RATING	IP20
CERTIFICATION	CE

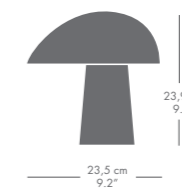

ORIENT™

COLOUR SURFACE Copper, Black, Aluminium
 Copper Polished, clear lacquer coated
 Black Matt lacquer
 Aluminium Brushed, clear lacquer coated

MATERIAL Copper Copper/Rosewood
 Black Aluminium/Rosewood
 Aluminium Aluminium/Oak

CORD LENGTH P1-P2 3 / 6 m
 P3 6 m

CORD Copper Black, textile
 Black Black, textile
 Aluminium Grey, textile

LIGHT SOURCE P1 E27 max 60W
 P2 E27 max 75W
 P3 E27 max 100W

ENERGY LABEL A++, A+, A, B, C, D
ISOLATION CLASS CLASS II
IP RATING IP20
CERTIFICATION CE

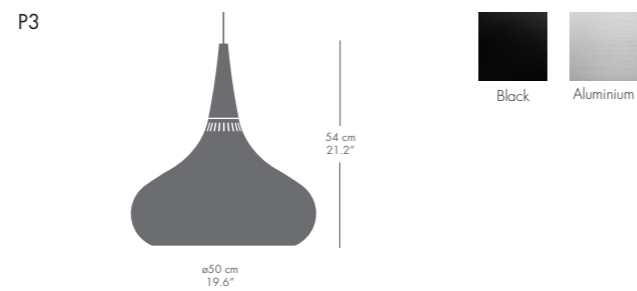
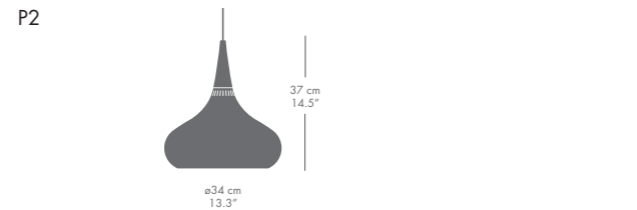
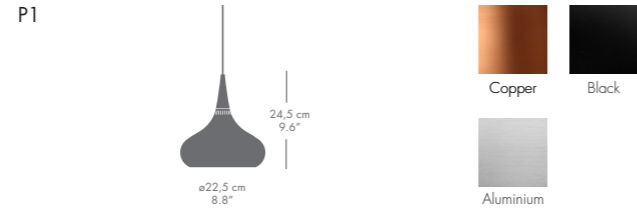

PALLAS™

COLOUR SURFACE White, Black
 High gloss lacquer

MATERIAL Shade: Steel
 Diffuser: Acid-treated opal glass
 Suspension: Metal wire

CORD LENGTH 6 m with wire
CORD White White, PVC
 Black Black, PVC

LIGHT SOURCE E27 max 200W

ENERGY LABEL A++, A+, A, B, C, D
ISOLATION CLASS CLASS II
IP RATING IP20
CERTIFICATION CE

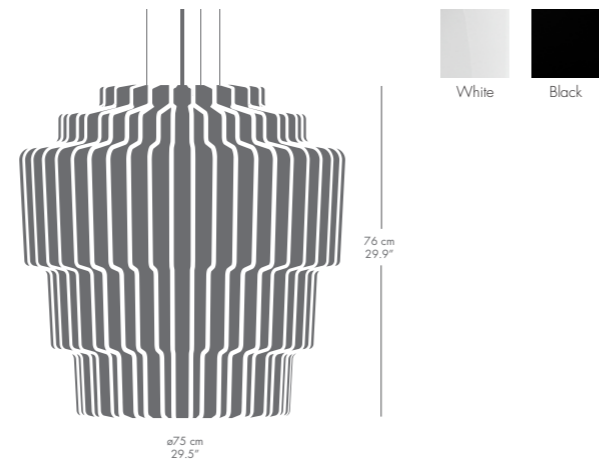

RADON™

COLOUR SURFACE Alba, Nigra
 Semi-matt lacquer

MATERIAL Shade: Sandblasted aluminium
 Base: Turned brass/steel bars

CORD LENGTH Wall 3,30 m
 Table 2,50 m
 Floor 2,50 m
CORD Black, PVC

LIGHT SOURCE E14 max 25W
ENERGY LABEL A++, A+, A, B, C, D
ISOLATION CLASS CLASS II
IP RATING IP20
CERTIFICATION CE

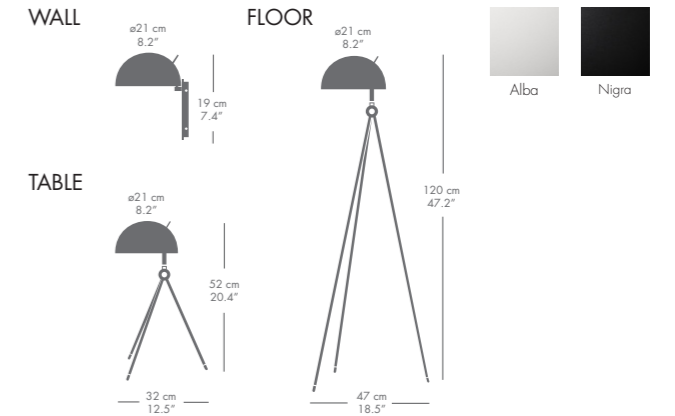

SUSPENCE™

COLOUR SURFACE White, Light grey, Black, Copper
 White Matt lacquer
 Light grey Matt lacquer
 Black Matt lacquer
 Copper Polished, clear lacquer coated

MATERIAL Shade: Aluminium
 Polished copper
 Diffuser: Polycarbonate (PC)

CORD LENGTH 3 / 6 m
CORD White Matt white, PVC
 Light grey Matt light grey, PVC
 Black Matt black, PVC
 Copper Matt black, PVC

LIGHT SOURCE P1: E27 max 53W
 P2: E27 max 100W

ENERGY LABEL A++, A+, A, B, C, D
ISOLATION CLASS CLASS II
IP RATING IP20
CERTIFICATION CE

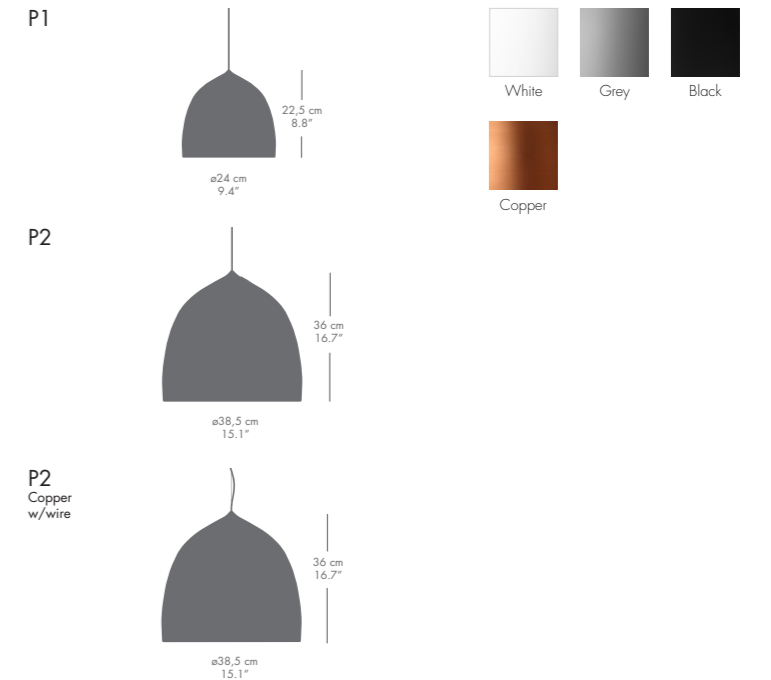

SUSPENCE™ NOMAD

COLOUR Opal
MATERIAL Polyethylene (PE)

CORD LENGTH 4 m
CORD Grey, PVC
 Red, PVC

LIGHT SOURCE E27 max 46W

ENERGY LABEL A++, A+, A, B, C, D
ISOLATION CLASS CLASS II
IP RATING IP20
CERTIFICATION CE

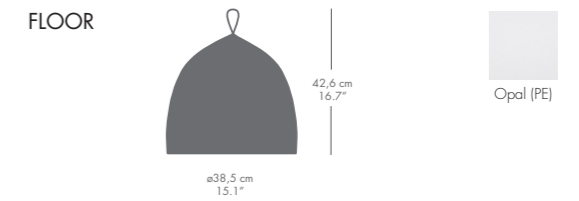

OVERVIEW COLLECTION/SIZES

	PENDANT	P0	P1	P2	P3	P4	WALL	TABLE	FLOOR
Aeon Rocket™			ø40 x 23,6 cm		ø60 x 33,2 cm				
AQ01™							h 48,3 cm	h 45,3 cm*	
Avion™	ø34,2 x 85 cm								
Bulb Fiction™	ø12,8 x 21 cm								
Calabash™			ø15,8 x 21 cm	ø22,4 x 30,5 cm	ø34 x 48,4 cm				
Caravaggio™		ø11 x 14,5 cm	ø16,5 x 21,6 cm	ø25,8 x 33,7 cm	ø40 x 51,6 cm	ø55 x 70,2 cm		h 51,7 cm*	h 151,5 cm
Caravaggio Matt™			ø16,5 x 21,6 cm	ø25,8 x 33,7 cm	ø40 x 51,6 cm	ø55 x 70,2 cm		h 51,7 cm*	
Caravaggio Opal™			ø16,5 x 21,6 cm	ø25,8 x 33,7 cm	ø40 x 51,6 cm	ø55 x 70,2 cm			
Caravaggio Read™							h 20,6 cm	h 50 cm	h 110 cm
Concert™			ø32 x 16,6 cm		ø55 x 32 cm				
Cross-Plex™								h 50 / 30 cm	
Dogu™	ø24 x 32,9 cm								
HL™ 410 OUTDOOR							ø41 x 39 cm		
Juicy™	ø43,5 x 44 cm								
KAISER idell™ 6556								h 47 cm	h 125 cm
KAISER idell™ 6580									h 125-135 cm
KAISER idell™ 6631	ø28,5 x 13,5 cm							h 42,5 cm	
KAISER idell™ 6718							d 47-89 cm		
Lullaby™			ø24 x 22,6 cm	ø43 x 39,6 cm	ø58,8 x 56 cm				
Mingus™			ø22 x 21,3 cm	ø34 x 32 cm					
Night Owl™								h 23,9 cm	
Orient™ Copper			ø22,5 x 24,5 cm	ø34 x 37 cm					
Orient™ Black/Aluminium			ø22,5 x 24,5 cm	ø34 x 37 cm	ø50 x 54 cm				
Pallas™	ø75 x 76 cm								
Radon™							ø21 cm	h 52 cm	h 120 cm
Suspence™			ø24 x 22,5 cm	ø38,5 x 36 cm					ø38,5 x 42,6 cm

*] Also available in Plug-In

Some models are only available in EU

